

STRADA
One-Piece Toilet, CEL
6330UC01

Product Features

- Vitreous china one-piece toilet
- Chair-height (16-1/2"), square bowl
- Anti-microbial, stain-resistant glaze
- 12" (305mm) rough-in

Flushing System

- High-performance, gravity flush
- 1.28 gallons (4.8 liters) per flush - EPA WaterSense, high-efficiency toilet (HET)
- Open bowl rim
- Fully glazed, 2-1/8" internal trapway
- Oversized 3" flush valve

Accessories Included

- Soft-closing, quick-release seat and cover
- Solid metal trip lever, Polished Chrome finish
- Bolt alcove cover tiles (set of 2)

Quality Assurance

- Factory flush-tested
- Limited lifetime product warranty



Dimensional Diagram

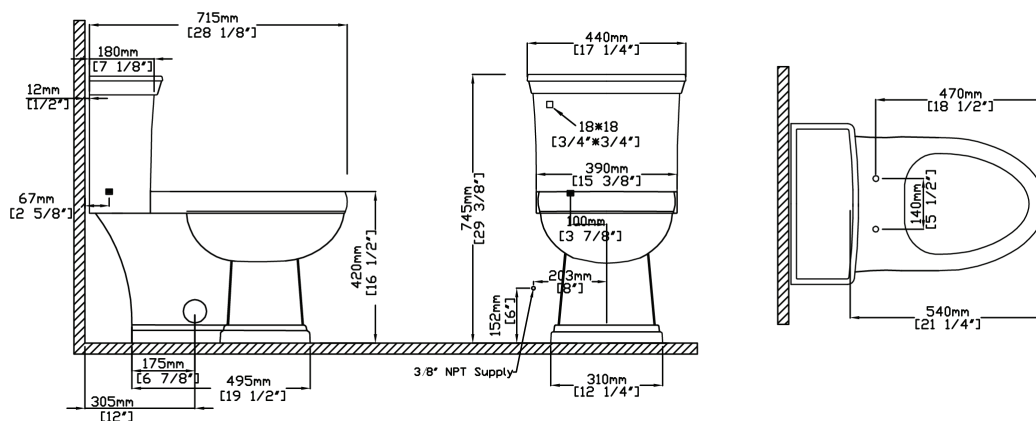





IMPORTANT: Dimensions are nominal and may vary within the range of tolerance per NSI Standard A112.19.2. These measurements are subject to change. No responsibility is assumed for use of superseded or voided pages.

PRODUCT OPTIONS & PARTS

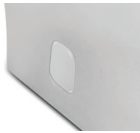
Glaze Color Options		
 White .01		

Toilet Seat Options		
 S-242		

Tank Lever & Hardware Options		
 F-65 (*Standard)	.500 Polished Chrome* .502 Polished Nickel .503 Satin Nickel .504 Polished Brass	.508 Venetian Bronze .01 White Enamel .05 Matte Black
 MC-300	.01 White	

Metal Finish Options						
 Polished Chrome .500	 Polished Nickel .502	 Satin Nickel .503	 Polished Brass .504	 Venetian Bronze .508	 White Enamel .01	 Matte Black .05

Compliance Certifications	
<ul style="list-style-type: none"> ASME A112.19.2M CSA B45.1 	 Meets the Americans With Disabilities Act (ADA) guidelines and ANSI A117.1 requirements for accessible building facilities. Check local codes.

Replacement Parts
Please contact Icera Customer Service at service@icerausa.com or by phone at 855-444-2372 for after-purchase support and information on replacement parts.